

Wiring Diagrams

C30CNE

C30CNE Electrically Held

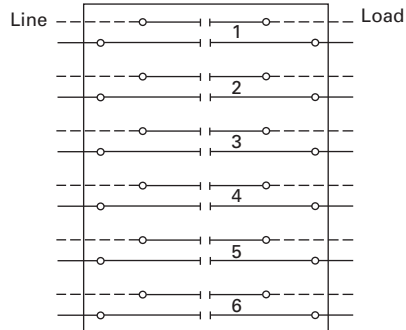

View A

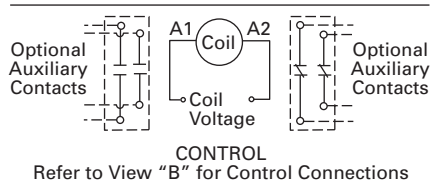

View B
Optional Pilot Devices for Electrically Held Contactor

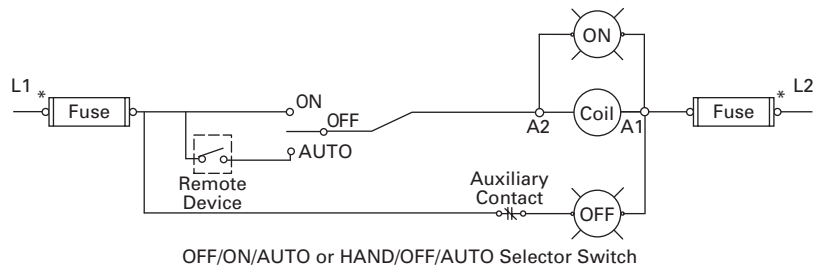
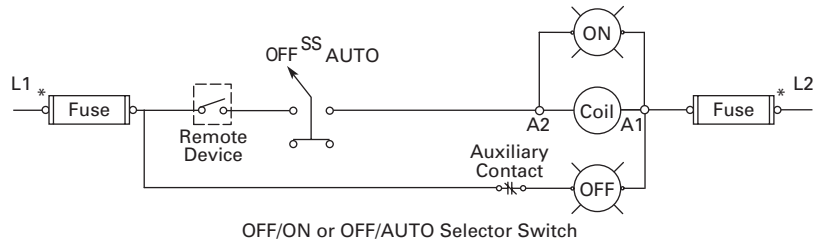
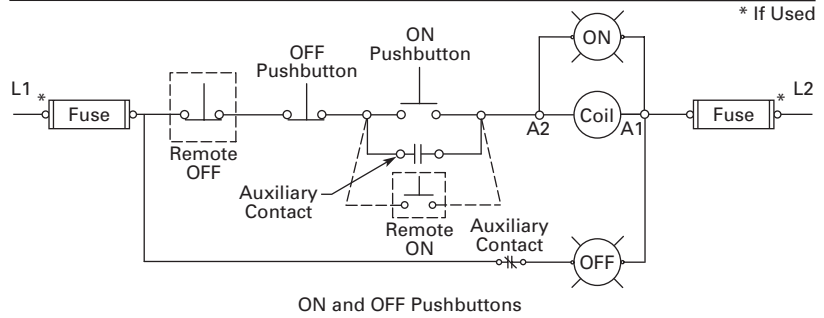

32.1

Lighting Contactors

Open Control

C30CNM

C30CNM Mechanically Held

Refer to View "A" for 2-/3-Wire Control Options

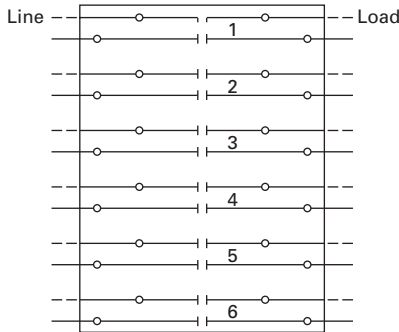

View A

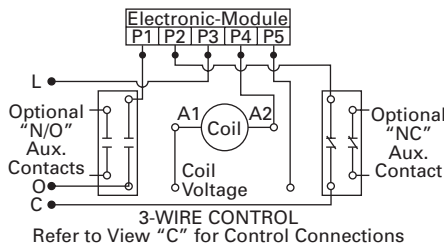
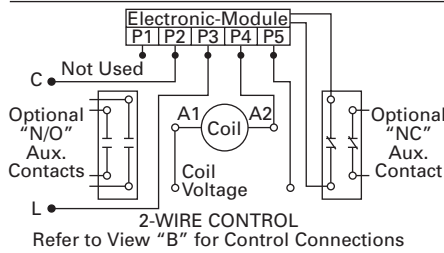

View B
Optional Pilot Devices for 2-Wire Control

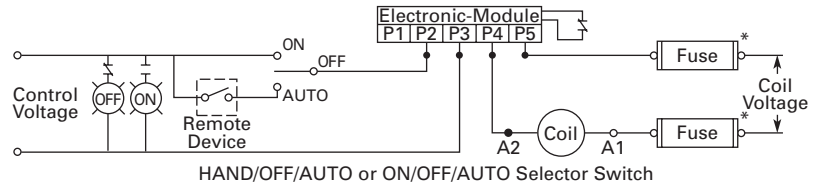
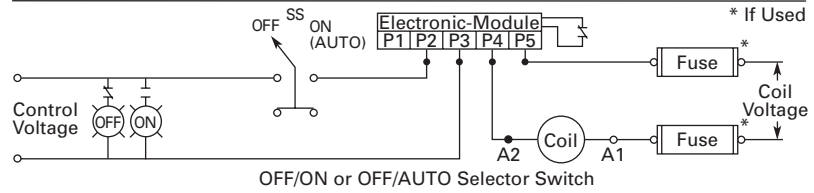

View C
Optional Pilot Devices for 3-Wire Control

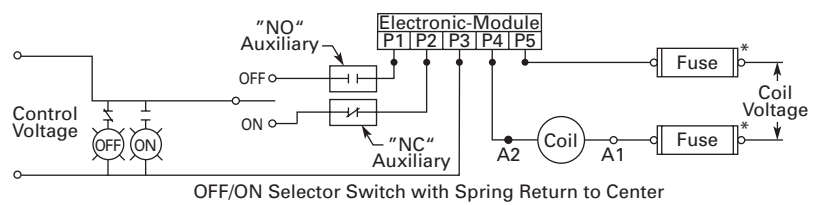
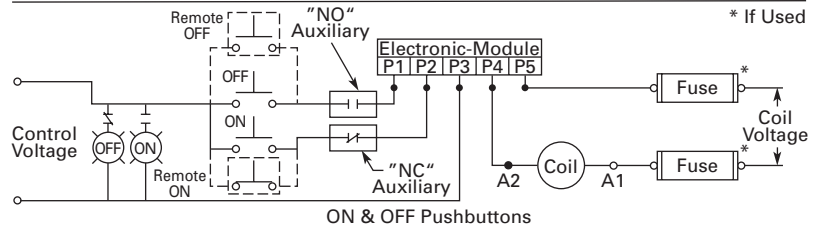

32